



**Universal grinding machine**  
with maximum flexibility  
satisfying the highest  
demands when processing  
complex components.



# Maximum flexibility for great challenges

**Universal grinding machines of the WOTAN® S6U series are designed for processing medium-sized and large workpieces. The workpiece spindle can absorb loads of up to 1 200 kg. Our flexible machine design enables us to optimize each machine for your specific grinding jobs.**

The WOTAN® S6U in its configuration as WOTAN® S6U-F is suitable for the internal, external and surface processing of chuck parts with a swing diameter of up to 820 mm and a length of up to approx. 80 mm that are clamped on one side only ("flying") without additional support.

Alternatively, it is also possible to grind shaft-type workpieces between centers externally without additional support. Here, the workpiece can have a maximum length of up to approx. 1 450 mm.

The WOTAN® S6U is therefore ideal for grinding internal diameters and internal front surfaces as well as external diameters and external front faces. Chuck parts can thus be processed effectively on 4 sides with the workpiece being clamped once only.

The internal grinding unit is used for the internal processing, while the separately working external and surface grinding unit is used for the external processing.

As an alternative, the machine can be configured with an extended work area as WOTAN® S6U-L. This version makes it possible to process shaft-type components with a length of up to 1 250/ 1 800 mm, apart from chuck parts clamped on one side only, for which, due to their geometry, a steady rest needs to be added. The diameter in the steady rest can range up to 500 mm.

This will ensure an effective 4-side processing with the workpiece being clamped once only which includes grinding internal diameters, internal front surfaces, external diameters and external front faces. However, external processing in this position will only be possible in front of the steady rest.

It goes without saying that shaft-type components (self-supporting, without any additional support) can be ideally ground externally between centers with such a machine design. The component length that can be clamped may, thanks to the longitudinal adjustment of the workpiece spindle headstock in Z-direction (L-adjustment), be extended to a maximum of 3 200 mm.

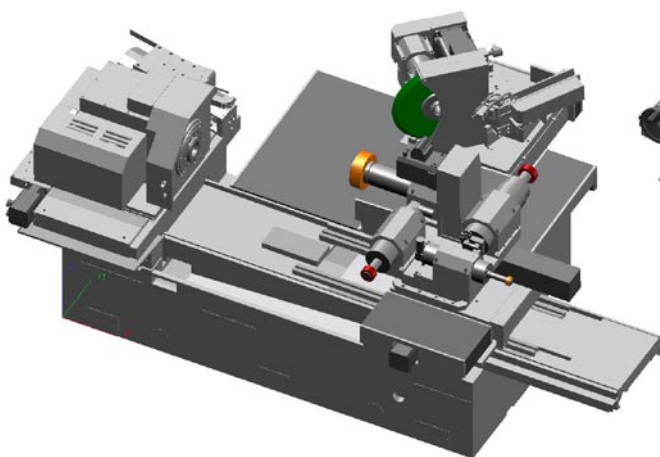

Example of the configuration of a WOTAN® S6U-F with 4 internal grinding spindles and an external grinding spindle

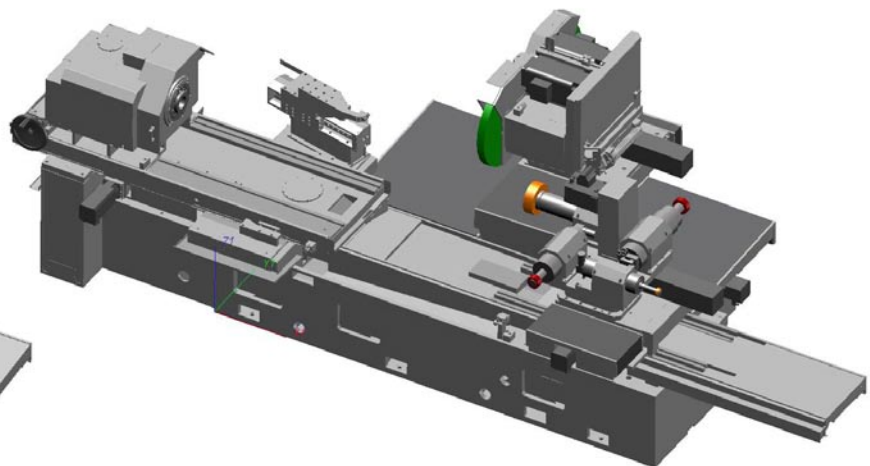

Example of the configuration of a WOTAN® S6U-L with 4 internal grinding spindles, 2 external grinding spindles and the longitudinal adjustment on the side of the workpiece spindle

## WORKPIECE SPINDLE

On the machining side, the machine is equipped with a swivel axis (B1 axis) which can either be manually operated (with an angle measuring system) or be CNC-controlled. The workpiece spindle headstock will be swiveled with the help of the B1 axis which allows not only a correction of the cylindricity but, in particular, also the **internal and external taper grinding** of chuck parts in an accurate way.

Moreover, the entire workpiece spindle headstock will be positioned on a transverse axis (U axis), so that the machine's work area can be extended by positioning the entire workpiece spindle headstock crosswise. Since the U axis is a positioning axis, it remains stationary during the grinding process.

## LARGE SELECTION OF SPINDLES

Depending on the accuracy requirements, the workpiece spindle can be designed as belt-driven or directly driven spindle or as spindle with a hydrostatic bearing. If the **workpiece spindle is equipped with a measuring system** (C axis), you can perform high-precision **non-round grinding operations** in various applications on a cylindrical grinding machine.

The internal grinding unit of the machine will be put up on a cross table that consists of a Z1 axis and an X1 axis. The X1 axis is mounted on the Z1 axis rectangular. Here, stepped internal diameter and internal front surfaces can be processed **economically and efficiently in one clamping**.

## OPTIONAL INTERNAL GRINDING SPINDLE TURRET

An optional **internal grinding spindle turret** (B2 axis) with **up to 4 internal grinding spindles** can increase the flexibility considerably without exchanging the spindles. It is either belt-driven internal grinding spindles or high-frequency **internal grinding spindles** that are used for this purpose. Belt-driven spindles can be manually exchanged which increases the variability even more.

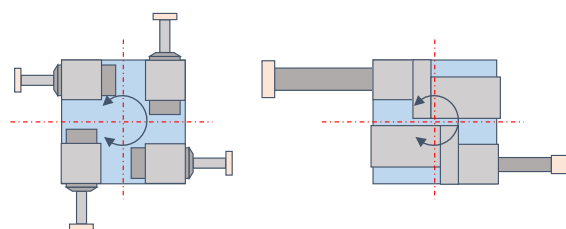

4 high-frequency spindles

2 belt-driven spindles

## EXTERNAL AND SURFACE GRINDING

Apart from the internal processing, **external grinding between centers** is, of course, also possible. In order to do so, an **additional tail-stock** will be put up on the internal grinding spindle turret (B2 axis). This configuration makes it also possible to install up to 3 internal grinding spindles for a wide range of internal grinding jobs.

The **separately working external and surface grinding unit** is – like the internal grinding unit – is mounted on a cross table consisting of a Z2 axis and an X2 axis. The X2 axis will again be positioned on the Z2 axis rectangular. In this way, **stepped external diameters and external front faces** can be processed economically and efficiently in one clamping.

The machine will be equipped in its basic configuration with a stationary external and surface grinding unit. The grinding unit can be positioned at angles of 30°/45°/90° in relation to the workpiece axis. If, as an example, the grinding unit is positioned at an angle of 30° or 45° in relation to the workpiece axis, an external and surface grinding wheel profiled on both sides can be used. This will allow the clean processing of external front faces by way of **peripheral grinding** and the processing of external diameters by applying **inclined plunge cut grinding** or **longitudinal grinding techniques**.

If the external and surface grinding unit is positioned at an angle of, say, 90° in relation to the workpiece axis, a straight (cylindrical) external grinding wheel can be employed, so that **external diameters** can be optimally processed by way of longitudinal grinding. It is, of course, also possible to grind **external front faces** by positioning the external grinding wheel on the face.

## EXAMPLE OF THE CONFIGURATION FOR THE B2 AXIS

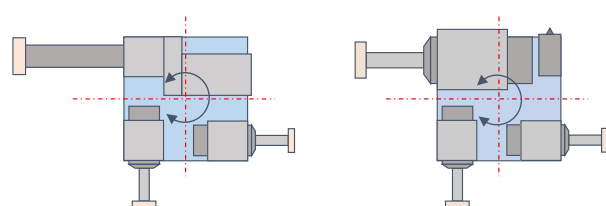

1 belt-driven spindle +  
2 high-frequency spindles

3 high-frequency spindles +  
1 tailstock

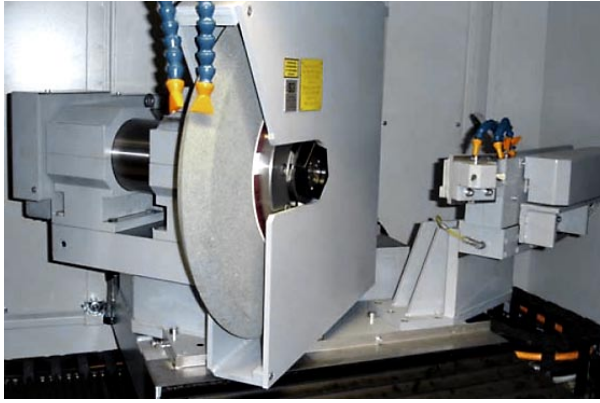

An example of an external and surface grinding unit at an angle of 45° in relation to the workpiece axis with external and surface grinding wheel profiled on both sides

#### OPTIONAL EXTERNAL GRINDING SPINDLE REVOLVER

The flexibility can be further increased – even without exchanging the spindles – by adding an external grinding spindle turret (B3 axis) with up to 4 external grinding wheels to the external and surface grinding unit. This will allow, as an example, the optimal grinding of **external tapers** on shaft-type components between centers in an optimal way.

External grinding wheels can also be used for **grinding external (male) threads** and much more, when properly dressed. A possible setup may contain, as an example, 1 external and surface grinding wheel profiled on both sides for grinding **external diameters** and **external front faces**, 1 cylindrical external grinding wheel for the **longitudinal grinding** of shaft-type components between centers and 1 external grinding wheel with **thread profile** for grinding external (male) threads.

Each of the up to 4 external grinding wheels can be precisely balanced by an **automatically working balancing system**.

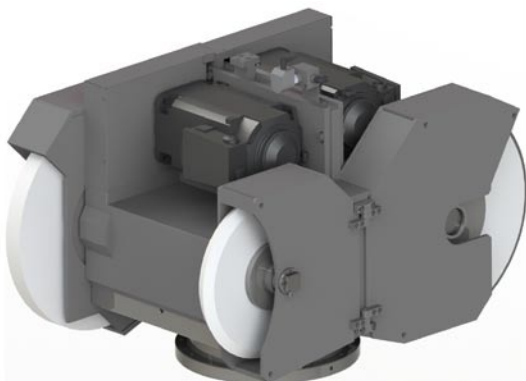

An example of a configured external grinding spindle revolver with 3 external grinding wheels

#### VARIOUS DRESSERS SELECTABLE

The machine is equipped both with an **internal dressing unit** and with an **external dressing unit**. Both dressing units can be equipped with **stationary and driven dressing tools**, which will allow working not only with conventional corundum grinding wheels but also with Cubic Boron Nitride (CBN) grinding wheels.

#### MODERN CONTROL AND EASY USER INTERFACE

The drive package is based on a **SINUMERIK 840 D control – SOLUTION LINE** – from SIEMENS with the latest generation of servo motors.

All machines are equipped with our own, user-friendly **operator interface with workshop oriented programming (WoP)** that allows an uncomplicated, menu-guided **operation of the machine and its programming without CNC knowledge**.

All operations necessary for the process allow the continuous handling of the machine, regardless of its operating status. The standard interface of SIEMENS is also available at the same time.

#### NUMEROUS OPTIONS AVAILABLE

Depending on the grinding job to be performed, we also integrate a **spark-in control & incision detection** via a fluid sensor system, more measuring equipment, re-tooling systems and much more.



An example of a 52-fold tool changer, with the changing process being intended for the complete processing of complex components in one clamping

# WOTAN® S6U at a glance:

## WOTAN® S6U-F

(without longitudinal adjustment)

## WOTAN® S6U-L

(with longitudinal adjustment of the workpiece spindlestock  
1 400mm | 2 000mm)

Work area of the machine		
swing/workpiece diameter in front of the swivel plate	mm (max.) 820	820
swing/workpiece diameter above the swivel plate	mm (max.) –	650
workpiece diameter in the steady rest	mm (max.) –	500
workpiece length that can be clamped		
› for components clamped on one side only (chuck parts)	mm (app.) 800	800
› for shaft-type components between centers	mm (max.) 1.450	2.950   3.200
› for shaft-type components with steady rest	mm (max.) –	1.200   1.800
grinding diameter during the internal grinding	mm (max.) 620	620
grinding depth during the internal grinding	mm (max.) 900	1.200
grinding diameter during the external/surface grinding	mm (max.) 800	800
grinding length during the external/surface grinding	mm (max.) 2.000	2.000
load-bearing capacity at the spindle head (200 mm from the spindle nose)		
› for components clamped on one side only (chuck parts)	kg (max.) 650	650
› for shaft-type components between centers	kg (max.) 650	650
› for shaft-type components with steady rest	kg (max.) –	1.300
Workpiece side / workpiece spindle stock		
› spindle belt-driven	standard	standard
› spindle directly driven	option	option
› with hydrostatic bearing	option	option
swiveling range of the B1 axis (manual with angle measuring system)	from/to ° +12 / -1	+12 / -1
swiveling range of the B1 axis (automatic; CNC-controlled)	from/to ° +12 / -1	+12 / -1
C axis for out of round grinding	option	option
U axis (CNC) for positioning the entire workpiece spindle stock crosswise		
› travel	mm (max.) 300	300
› resolution	mm 0,0001	0,0001
› minimum adjusting increment	mm 0,001	0,001
› maximum speed	m/min 15	15
adjustment of the workpiece spindle stock in Z-direction	mm (max.) –	1.400   2.000
option to use steady rests	no	yes
option of external grinding between centers	yes	yes
coolant flow in through the workpiece spindle	option	option
incision detection/spark-in control via the fluid sensor system when grinding	option	option

**WOTAN® S6U-F**

(without longitudinal adjustment)

**WOTAN® S6U-L**

(with longitudinal adjustment of the workpiece spindlestock 1 400mm | 2 000mm)

**Internal grinding unit**

## Z1 axis (CNC)

› travel	mm (max.)	800 / 1.100	800 / 1.100 / 1.380
› resolution	mm	0,0001	0,0001
› minimum adjusting increment	mm	0,001	0,001
› maximum speed	m/min	15	15

## X1 axis (CNC)

› travel	mm (max.)	245	245
› resolution	mm	0,0001	0,0001
› minimum adjusting increment (on the radius)	mm	0,0005	0,0005
› maximum speed	m/min	15	15

stationary grinding spindles (without grinding spindle turret)		1	1
internal grinding spindle turret (B2 axis)		option	option
› grinding spindles on a grinding spindle turret	max. Pcs.	4	4
› grinding spindles on a turret with tailstock	max. Pcs.	3	3
continuously adjustable setting of the spindle speed		standard	standard
grinding with conventional corundum grinding wheels		standard	standard
grinding with CBN grinding wheels		option	option

**Internal dressing unit**

designed to be operated with stationary dressing tools		standard	standard
designed to be operated with driven dressing tools		option	option
spark-in control via acoustics emission (AE) sensors during dressing		option	option

**Automatic re-tooling system**

for grinding tools, measurement sensors etc.		option	option
--	--	--------	--------



**WOTAN® S6U-F**

(without longitudinal adjustment)

**WOTAN® S6U-L**

(with longitudinal adjustment of the workpiece spindlestock 1 400mm | 2 000mm)

**External and surface grinding unit****Z2 axis (CNC)**

› travel	mm (max.)	830/1.200/2.200	830/1.200/2.200
› resolution	mm	0,0001	0,0001
› minimum adjusting increment	mm	0,001	0,001
› maximum speed	m/min	15	15

**X2 axis (CNC)**

› travel	mm (max.)	500	500
› resolution	mm	0,0001	0,0001
› minimum adjusting increment (on the radius)	mm	0,0005	0,0005
› maximum speed	m/min	15	15

**stationary external/surface grinding unit (without turret)**

standard

standard

› external grinding wheels (stationary)	max. Pcs.	1	1
› dimensions of external grinding wheel (standard)	mm (max.)	Ø600 x 50 x Ø203,2	Ø600 x 50 x Ø203,2

**external/surface grinding unit with spindle turret (B3 axis)**

option

option

› external grinding wheels	max. Pcs.	4	4
› dimension of the straight external grinding wheel (standard)	mm (max.)	Ø600 x 50 x Ø203,2	Ø600 x 50 x Ø203,2
› dimension of the profiled external grinding wheel (standard)	mm (max.)	Ø600 x 50 x Ø203,2/ Ø450 x 50 x Ø127	Ø600 x 50 x Ø203,2/ Ø450 x 50 x Ø127

**automatic balancing system for external grinding spindles**

standard

standard

**continuously adjustable setting of the spindle speed**

standard

standard

**grinding with conventional corundum grinding wheels**

standard

standard

**grinding with CBN grinding wheels**

option

option

**External dressing unit****designed for stationary dressing tools**

standard

standard

**designed for driven dressing tools**

option

option

**spark-in control via acoustics emission (AE) sensors during dressing**

option

option

**Measuring instruments****measurement sensor for zero point detection**

option

option

**further measuring equipment**

on request

on request

**laser measurement of all CNC linear axes (at the WEMA)**

yes

yes

**Machine control & operation****SINUMERIK 840 D control SOLUTION LINE from SIEMENS**

yes

yes

**proprietary operating system from WOP Glauchau®**

yes

yes

**option of remote diagnosis**

yes

yes

**CNC knowledge required for operating the machine**

none

none

**Other items****maintenance contract**

on request

on request

**spare & wear part package**

on request

on request

**operator training/flanking production support/etc.**

on request











on request



MEMBERS OF THE NSH-GROUP > WWW.NSHGROUP.COM





Our experts will accompany you on the way from the first inquiry to the after-sales service thus ensuring the daily operations of your machine, so that you will get an optimal grinding machine from us.

-  exact agreement of the requirements
-  individual offer for a grinding machine
-  individual design
-  production
-  quality assurance
-  test grinding
-  pre-acceptance of the machine
-  delivery & installation
-  training & familiarization
-  after-sales service

We will be pleased to demonstrate the potential of all our WOTAN® machines at our headquarters in Glauchau, where we also accept grinding jobs for test purposes and on a contract basis.



#### Werkzeugmaschinenfabrik Glauchau GmbH

-  Dieselstrasse 2  
08371 Glauchau · Germany
-  +49 3763 61-0
-  +49 3763 61-122
-  wema-glauchau@nshgroup.com
-  WWW.WEMA-GLAUCHAU.COM

STATUS: MARCH 8, 2018 · SUBJECT TO CHANGES

THE INFORMATION CONTAINED IN THIS BROCHURE IS MEANT FOR CUSTOMERS AND OTHER INTERESTED PARTIES BUT DOES NOT CONSTITUTE THE ASSURANCE OF PRODUCT PROPERTIES IN A LEGAL SENSE.